

# Instructions for use: SÉCURIDRAP® SELFIA®



## WARNING:

Please read all of the instructions, precautions and warnings before use. Failure to comply with these indications, contra-indications, warnings and precautions, and failure to have repairs performed by a person certified by Mulliez-Flory, may pose a risk, including a risk of death for the patient.

## 1 - INTENDED USE OF THE PRODUCT

### INDICATION

Sécuridrap® Selfia® is a mechanical restraint device for use **with bed rails** to prevent:

- Overnight falls
- Excessive wandering and/or exhaustion due to wandering
- Reaching and/or damaging drips and urinary protections.

Sécuridrap® Selfia® is indicated for overnight use and cannot be used 24/7.

### TARGET POPULATION

Sécuridrap® Selfia® is intended to be used by aged patients suffering cognitive issues (or similar) and/or who are disoriented and/or have low muscle tone.

Restraint is a last resort option, to be used when nothing else is suitable for the patient and all other means have been tried. As such, the decision to prescribe Sécuridrap® Selfia® must be made by the doctor responsible for the patient's ethical and clinical decisions, after consulting with other health professionals in terms of:

- An assessment of the benefit to risk ratio
- Information known about the patient: their level of agitation, resources, daytime behaviour, etc.

An explanation for the prescription must be recorded in the patient's medical records.

## 2 - CONTRA-INDICATIONS

Use of the Sécuridrap® Selfia® is formally contra-indicated for:

- Adult patients on a psychiatric ward
- Patients with agitation or significant agitation:
  - Patients who, when they go to bed at night, are anxious and get agitated, hitting and shaking the rails.
  - Patients who appear to be good candidates for this product following clinical observations, but who become agitated once strapped into the Sécuridrap® Selfia®.
- Intolerance to the product: patient is clearly not comfortable
- Patients able to:
  - extract themselves or detach the product.
  - unlock the bed rails themselves.

## 3 - PRODUCT DESCRIPTION

### NOTE:

Sécuridrap® Selfia® is a Class 1 safety bedding **medical device** (restraining equipment).

Sécuridrap® Selfia® is in the form of a sleeping bag whose upper section is fitted with a neck opening and sleeves. The bedding interior features an adjustable pelvis support to hold the patient's pelvis while sleeping.

The bedding is for use on hospital beds and is solidly attached to the patient's bed with **five fastener straps** distributed as follows:

- Two fastener straps at the pelvis, located either side of the Sécuridrap® Selfia®.

- Two fastener straps at the lower leg, located either side of the Sécuridrap® Selfia®.

- One fastener strap located at the bottom of the bedding, which is also used to lock the bedding zip.

The five fastening straps attach the Sécuridrap® Selfia® to the hospital bed frame.

The Sécuridrap® Selfia® is available in four sizes to fit the patient's morphology. The size is shown on the label and by the colour code on the neck opening.

The Sécuridrap® Selfia® size to patient morphology correlation is shown in **Table 1** below.

Size	Morphology	Colour code
Size S	Under 55 kg	Dark Blue
Size M	55 to 75 kg	Green
Size L	75 to 95 kg	Grey
Size XL	Over 95 kg	Sky Blue

The perforations on either side of the waist are provided for the placement of a subcutaneous perfusion or a probe.

Sécuridrap® Selfia® can also be considered as bedding and complies with the requirements set out in Decree No. 2000-164 of 23 January 2000.

## 4 - TRAINING AND SUPERVISION

### WARNING:

Patients must be placed in a Sécuridrap® Selfia® by medical staff who know the safety rules specific to using this product.

### NOTE:

The mandatory training must be provided by trainers authorised by the manufacturer.

Training is provided by the manufacturer for the first delivery of Sécuridrap® Selfia® to an establishment, and subsequently upon request.

A demonstration video on how to use the Sécuridrap® Selfia® is available at: [www.mulliez-flory.com](http://www.mulliez-flory.com)

### WARNING:

It is **necessary** to perform close clinical observation of the patient's behaviour and reaction once strapped into the Sécuridrap® Selfia® during **the first few hours of the first three nights**.

Every night, when using the device, checks must be made at regular intervals.

If any distress is caused (agitation, insomnia, distress, anxiety, etc.), stop using the Sécuridrap® Selfia® and reassess the prescription.

## 5 - INSTRUCTIONS FOR USE

### 5.1 Choosing the size

Choose the Sécuridrap® Selfia® size to fit the patient's morphology in accordance with the indications in **Table 1**.

#### **WARNING:**

Choosing the right Sécuridrap® Selfia® size to fit the patient's morphology is crucial to the patient's safety. The wrong size may put the patient at risk. *(step 1/6 for the product)*

### 5.2 Placing the patient

#### **WARNING:**

Before each use of the Sécuridrap® Selfia®, checks must be made on the condition of the Sécuridrap® Selfia® (fabric condition, stitching, straps, pelvis support and zips) and on the bed rails (operating correctly).

Place the Sécuridrap® Selfia® on the hospital bed by aligning the bottom of the Sécuridrap® Selfia® with the bottom edge of the mattress.

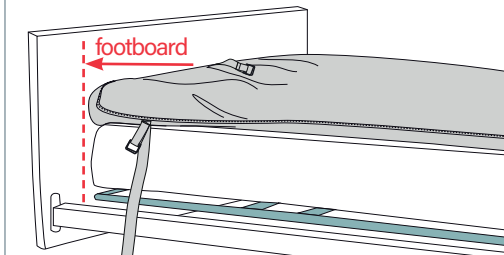
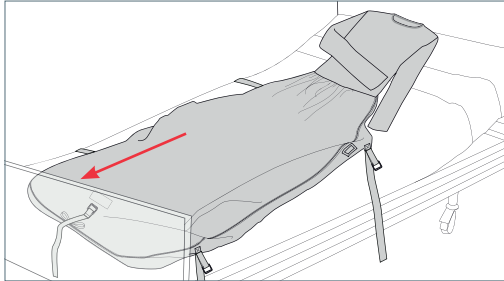

Attach the four side straps to the internal frame of the bed (mobile part of adjustable beds), ensuring the mattress is not compressed. Start with the two lower leg straps, then attach the two pelvis straps.

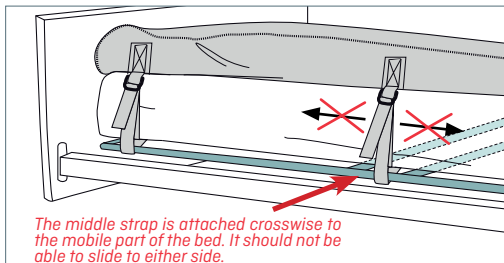

Attach the straps, making sure not to compress the mattress.

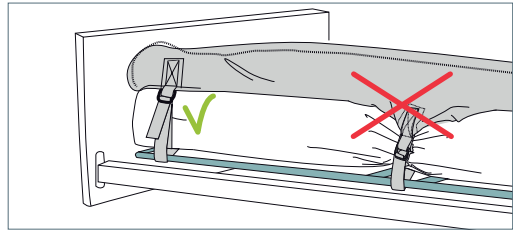

#### **WARNING:**

The straps must be attached to the mobile, internal frame of the bed. The two straps at the pelvis must be attached crosswise and must not be able to slide. Failure to comply with this safety instruction may put the patient at risk. *(step 2/6 and 3/6 for the product)*

Before the patient gets in, open the Sécuridrap® Selfia® from the foot of the bed to the sleeve cuffs, raising the upper sheet towards the headboard and ensuring the neck opening is clear.

Open the pelvis support and lay it flat on the bottom Sécuridrap® Selfia® sheet.

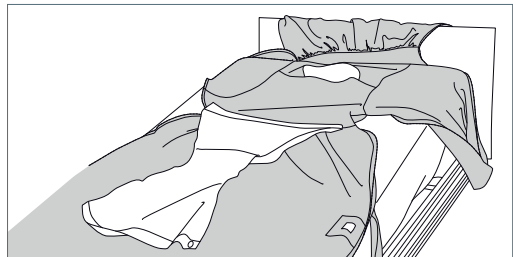

Place the person on top of the Sécuridrap® Selfia® by sitting them in the centre of the pelvis support, then laying them down, making sure to position the head opposite the neck opening.



Close the pelvis support by bringing the loose section between the patient's legs. Pull the loose section up towards the patient's waist and attach the buttons to the buttonholes located on the elastic bands.

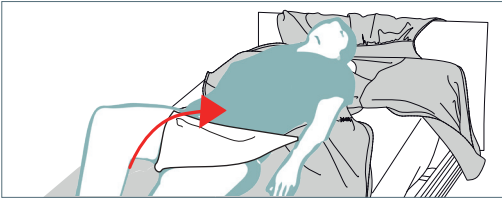

**WARNING:**

The pelvic support must be correctly attached and adjusted to prevent the patient sliding around inside the sleeping bag. Failure to comply with this safety instruction may put the patient at risk. (step 4/6 for the product)

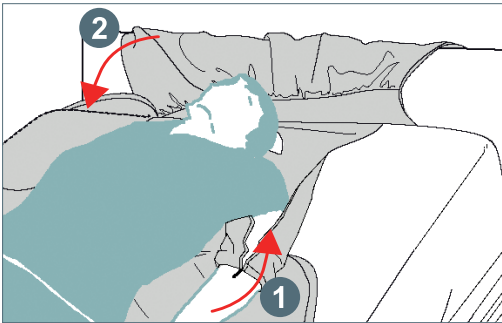

1 - Slip the patient's arms into the sleeve cuffs and push the cuffs up without closing them.

2 - Pull the Sécuridrap® Selfia® over the patient's head by placing one hand on the patient's forehead to guide and ease the neck opening over the patient's head while pulling down on the top of the Sécuridrap® Selfia®.

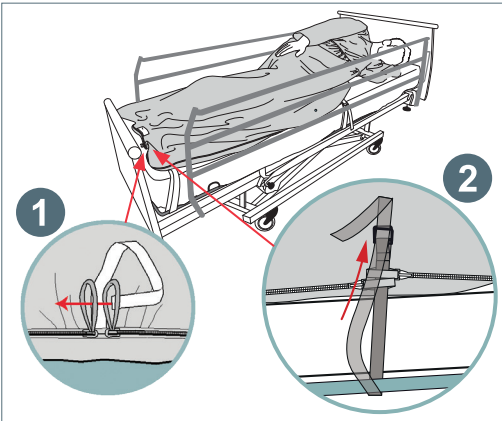

Close the Sécuridrap® Selfia® all the way to the bottom using the zips.

Once the zip is fully closed, thread the strap at the bottom end of the bedding through the two zip loops and attach the strap to the mobile, internal part of the bed frame.

**WARNING:**

The lower leg strap must be attached to the mobile, internal frame of the bed. Failure to comply with this safety instruction may pose a risk to the patient including a risk of death. (step 5/6 for the product)

Fold down the sheet, blanket or duvet.

Raise the two bed rails and check they operate correctly and are locked.

Lower the bed to its lowest position.

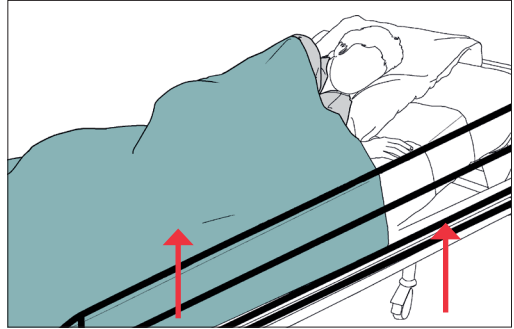

**WARNING:**

The Sécuridrap® Selfia® is intended for use with bed rails. It is recommended to use bed rails with a locking system at the foot of the bed, out of reach of the patients. The bed rails must be raised. Partial rails are prohibited. The bed must be in its lowest position. Failure to comply with this safety instruction may pose a risk to the patient including a risk of death. (step 6/6 for the product)

During the first hours of the first three nights of using the device for the patient, the nursing staff must perform close clinical observations.

Every night, checks must be made at regular intervals.

During night changes and treatments, the safety rules must also be followed:

- The pelvis support must be reattached after the change.
- The zip must be secured by the strap at the end of the bedding.
- The bed rails must be raised up again.
- The bed must be put back in the lowest position.

In the morning, when removing the Sécuridrap® Selfia®, the product must be checked to ensure it is in good condition before being sent to the laundry.

## 6 - COMPLICATIONS

The report on the Sécuridrap® Selfia® shows that when the product is used in accordance with the indications, contra-indications and warnings given in these instructions, there have been no reported complications associated with using the Sécuridrap® Selfia®.

However, using the Sécuridrap® Selfia® may result in some patients becoming agitated and uncomfortable. In this case, for the patient's wellbeing and safety, another type of restraint better suited to the situation must be used.

Finally, remember that failure to follow the indications, contra-indications and warnings given in these instructions may pose a significant risk to the patient's health, including a risk of death.

## 7- CLEANING THE SÉCURIDRAP® SELFIA®

Sécuridrap® Selfia® must be cleaned before each use.

Cleaning the Sécuridrap® Selfia® must be done with:

- all zips completely closed.

Cleaning instructions:

- Resistant to chlorine.
- Wash at up to 85°C.
- Calendering and wringing prohibited.
- Tumble dry only.
- No need to iron.





## 8 - CUSTOMER SERVICE

When a product is received (in its original packaging) and, despite all the care taken in producing it, it is found to be defective, Mulliez-Flory will repair or exchange the item.

After first use, in the event of a defect or alteration of the product, you will need to contact the Mulliez-Flory Customer Service team to decide what to do next.

In the interests of patient safety, it is strictly prohibited for you to repair or modify the Sécuridrap® Selfia®.

## 9 - SYMBOLS

				
Manufacturer	Manufacture date	Product code	Batch number	Warnings. Check attached documentation

## 10 - PRODUCT CODES

Product code	Size	Description
036547W01B0	S	Sécuridrap® Selfia® white Size S
036547W01B0	M	Sécuridrap® Selfia® white Size M
036547W01B0	L	Sécuridrap® Selfia® white Size L
036547W01B0	XL	Sécuridrap® Selfia® white Size XL
036547B01B0	S	Sécuridrap® Selfia® Blue Size S
036547B01B0	M	Sécuridrap® Selfia® Blue Size M
036547B01B0	L	Sécuridrap® Selfia® Blue Size L
036547B01B0	XL	Sécuridrap® Selfia® Blue Size XL



**MULLIEZ-FLORY**  
SANTÉ

Demonstration video  
available at:

[www.mulliez-flory.com](http://www.mulliez-flory.com)

### Mulliez-Flory

Route de St Aubin  
49710 Le Longeron, France  
Tel: +33 (0)2 41 63 78 10  
Fax: +33 (0)2 41 46 60 19  
Email: [contact@selfia.com](mailto:contact@selfia.com)

